

1.1.1.1 Standard Photodiode Sensors

20pW to 300mW

Features

- Spectral range including UV and IR
- Very large dynamic range
- Swivel mount for hard to measure places
- Comes with filter in / filter out options
- Fiber optic adapters available

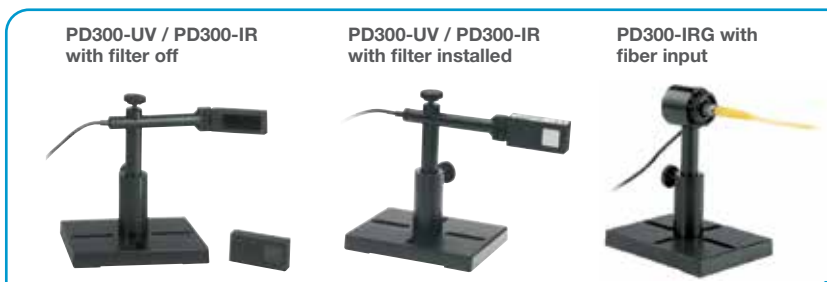

Model	PD300-UV/ PD300-UV-193			PD300-IR			PD300-IRG		
Use	Lowest powers from 200-1100nm			Low powers from 700-1800nm			Telecom wavelength fiber and free space measurements		
Detector Type	silicon			Germanium			InGaAs		
Aperture	10x10mm			Ø5mm			Ø5mm for free space beams		
Calibration Uncertainty nm	±1.1% 430-1000 (c)			±2.4% 700-1430 (c)			±2.4% 900-1430 (c)		
Filter Mode	Filter out		Filter in	Filter out		Filter in	Filter out		Filter in
Spectral Range nm	200 - 1100		220 - 1100	700-1800		700-1800	900 - 1630		950 - 1630
Power Range	20pW to 3mW		2µW to 300mW	5nW to 30mW		2µW to 300mW	20pW to 800µW		1µW to 200mW
Power Scales	3mW to 3nW and dBm		300mW to 300µW and dBm	30mW to 30nW and dBm		300mW to 300µW and dBm	800 µW to 800pW and dBm		300mW to 30µW and dBm
Resolution nW	0.001		100	0.01		NA	0.0001		1
Maximum Power vs. Wavelength	nm	mW	mW	nm	mW	mW	nm	mW	mW
	250 - 350	3	300	800	12	120	<1000	0.8	200
	400	3	300	1000-1300	30	300	1100	0.8	200
	600	3	300	1400	30	250	1200	0.8	200
	800 - 950	2.5	150	1500	30	100	1300	0.8	200
1064	3	300	1600	30	100	1550	0.8	200	
>1600			1800	30	300	>1600	0.8	200	

Accuracy (including errors due to temp. variations)

% error vs Wavelength nm (b)	±10	200-230	±10	220-300	±5	700-800	±6	700-900	±3	1000-1600	±6	1000-1600
	±7	230-300	±4	300-420	±4	800-1700	±5	900-1700	±5 ^(a)	900-1000 & 1600-1630	±8 ^(a)	900-1000 & 1600-1630
	±3	300-420	±3	420-980	±7	1700-1800	±9	1700-1800				
	±2	420-980	±7	980-1100								
Damage Threshold W/cm ²	10		50	10		50	5		50	5		50
Max Pulse Energy µJ	1		50	0.75		2	1		100	1		100
Noise Level for filter out pW	±1			200			±300fW at 1550 nm and 1s average					
Response Time with Meter s	0.2			0.2			0.2			0.2		
Beam Position Dependence	±2%			±2%			±1% over 80% of aperture					
Fiber Adapters Available (see page 33)	ST, FC, SMA, SC			ST, FC, SMA, SC			FC, FC/APC, SMA					
Compliance	CE, UKCA, China RoHS			CE, UKCA, China RoHS			CE, UKCA, China RoHS					
Version							V2					
Part Number	7Z02413/7Z02413A ^(a)			7Z02412			7Z02495					

Notes: (a) Assuming temperature range between 18-26 degrees – outside of this range add additional error per temperature dependence graph
 (b) Same as above with additional calibration point at 193nm accuracy ±6%
 (c) For calibration uncertainty of wavelengths outside of this range see table on page 24

* For graphs see page 31-32

PD300-UV / PD300-IR filter installed (Ø5mm for PD300-IR only)

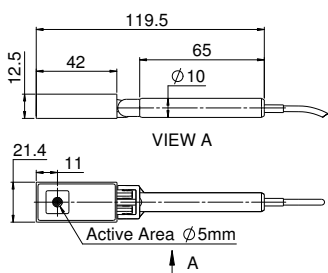

PD300-UV / PD300-IR filter off (Ø5mm for PD300-IR only)

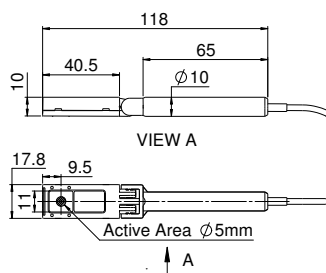

PD300-IRG

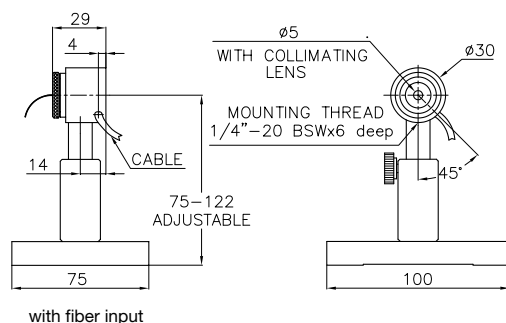

1.1.1.4 Graphs

Temperature Coefficient of Sensitivity

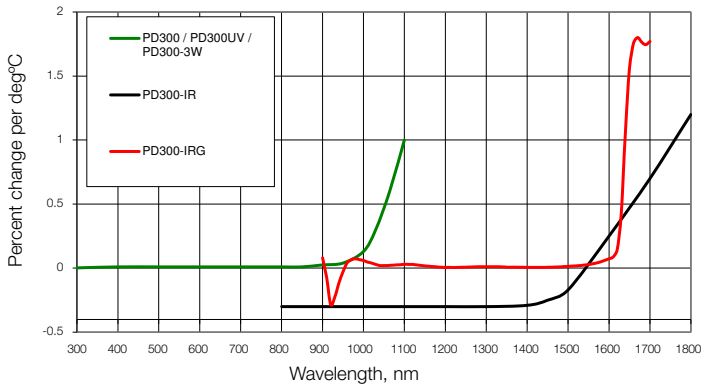

PD300 Angle Dependence

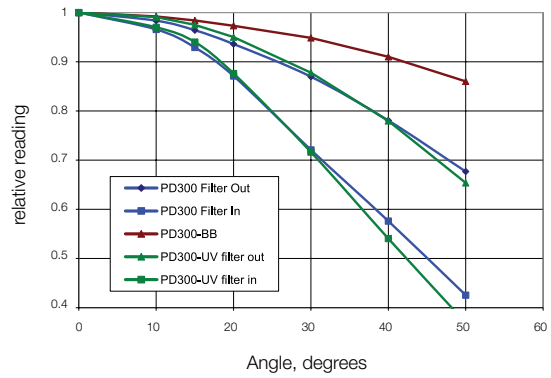

Dependence of Sensitivity on Numerical Aperture (PD300 - IRG)

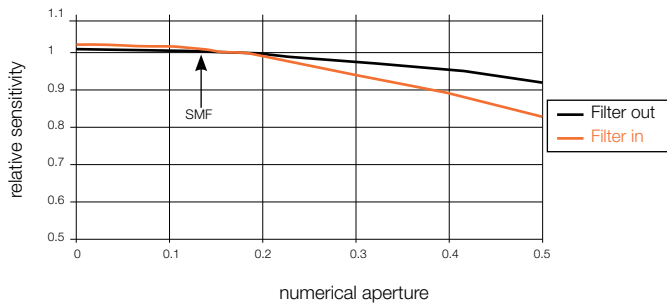

- Note:
1. Graph assumes equal intensity into all angles up to maximum N.A.
 2. Calibration is done with SMF, N.A. 0.13

PD300-CIE Spectral Response vs. CIE Curve

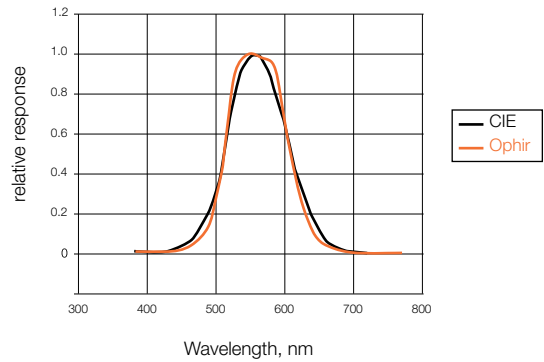

Typical Sensitivity Curve of PD300-BB Sensors

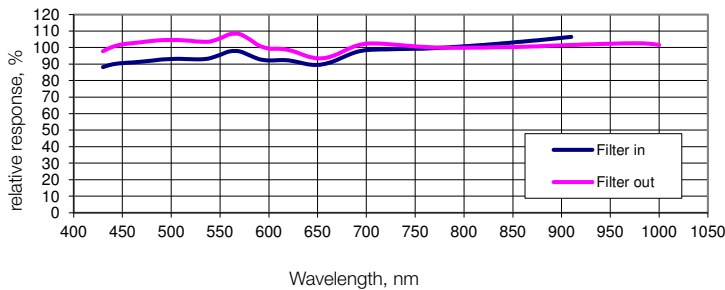

BC20 Relative Spectral Response

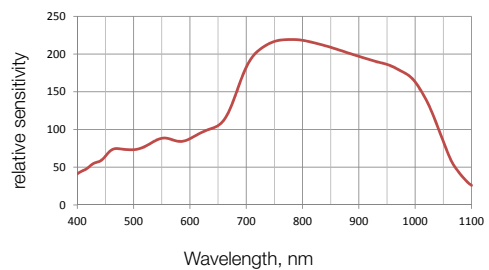

Approximate Spectral Response

Relative to 633nm or 1550nm

PD300 / PD300R

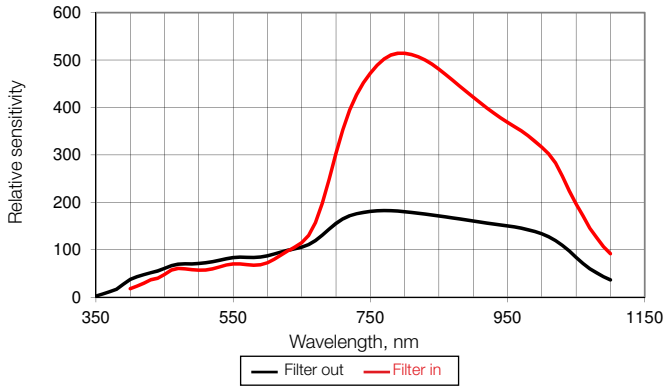

PD300-UV / PD300R-UV

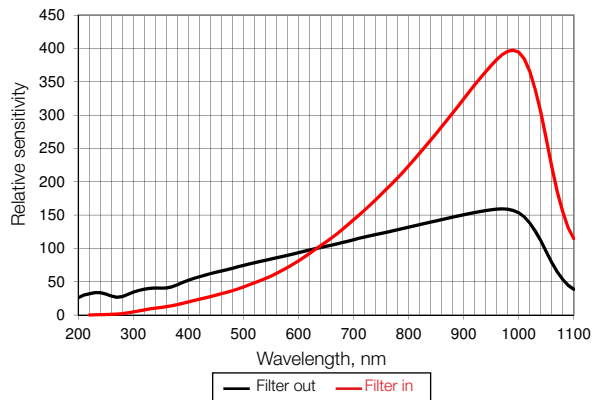

PD300-IR / PD300R-IR

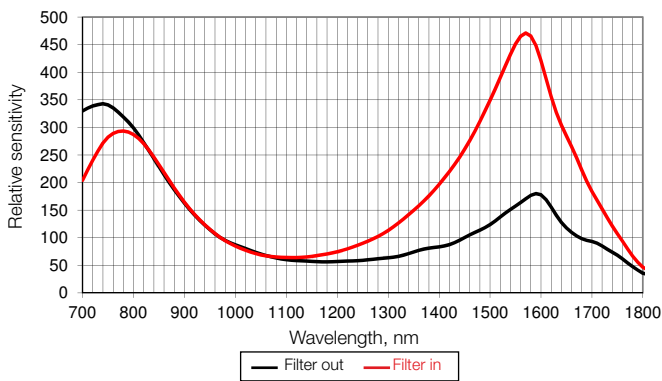

PD300-TP

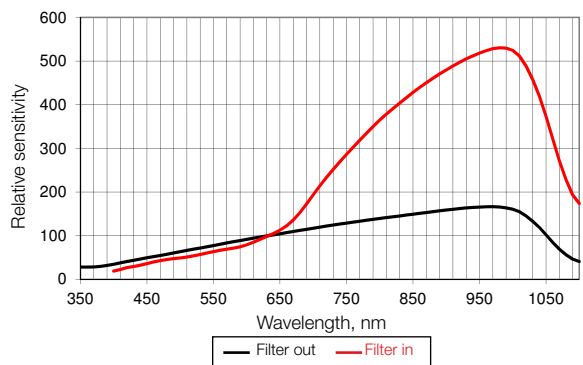

PD300-3W / PD300R-3W

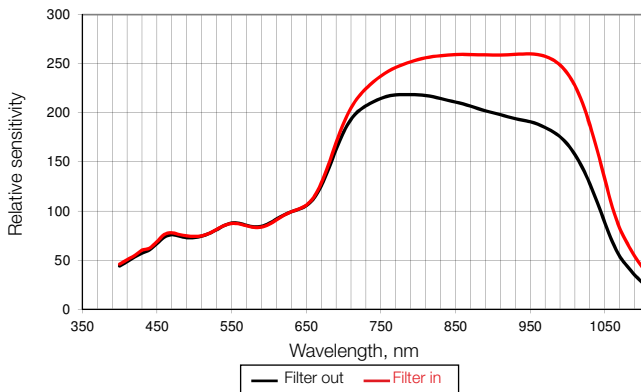

PD300-IRG

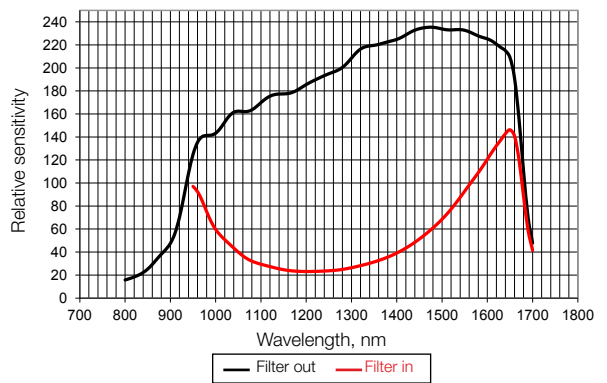

PD300-1W

